



SPECIFICATION

宏致電子股份有限公司

桃園縣中壢市東園路13號

No.13, Dongyuan Rd., Zhongli City,

Taoyuan County 320, Taiwan (R.O.C.)

TEL: +886-3-463-2808

FAX: +886-3-463-1800

SPEC. NO.: PS-52507-XXXXX-XXX REVISION: A

PRODUCT NAME: 1.0 mm PITCH EASY ON FPC CONN.

SMT R/A B/C TYPE

PRODUCT NO: 52507 SERIES

PREPARED: JAMESLEN.WANG DATE: 2018/12/26	CHECKED: RYAN.LIU DATE: 2018/12/26	APPROVED: SEAN.WANG DATE: 2018/12/26
---	---	---



TITLE: 1.0 PITCH EASY ON FPC CONN SMT R/A B/C TYPE

RELEASE DATE: 2018/12/26

REVISION: A

ECN No: ECN-1812458

PAGE: **2** OF **15**

1	REVISION HISTORY	3
2	SCOPE.....	4
3	APPLICABLE DOCUMENTS	4
4	REQUIREMENTS	4
5	PERFORMANCE	5
6	INFRARED REFLOW CONDITION.....	8
7	PRODUCT QUALIFICATION AND TEST SEQUENCE.....	9
8	CONNECTOR OPERATION	10



Aces P/N: **52507 series**

TITLE: **1.0 PITCH EASY ON FPC CONN SMT R/A B/C TYPE**

RELEASE DATE: 2018/12/26

REVISION: A

ECN No: ECN-1812458

PAGE: **3** OF **15**

1 Revision History

Rev.	ECN #	Revision Description	Prepared	Date
A	ECN-1812458	NEW PROJECT SPEC	JAMESLEN	2018.12.26

TITLE: **1.0 PITCH EASY ON FPC CONN SMT R/A B/C TYPE**

RELEASE DATE: 2018/12/26

REVISION: A

ECN No: ECN-1812458

PAGE: **4** OF **15**

2 SCOPE

This specification covers performance, tests and quality requirements for **1.0 mm Pitch Easy On FPC CONN. SMT R/A B/C TYPE**.

ACES Part/Number : 52507 SERIES

3 APPLICABLE DOCUMENTS

EIA-364: ELECTRONICS INDUSTRIES ASSOCIATION

4 REQUIREMENTS

4.1 Design and Construction

- 4.1.1 Product shall be of design, construction and physical dimensions specified on applicable product drawing.
- 4.1.2 All materials conform to R.o.H.S. and the standard depends on TQ-WI-140101.

4.2 Materials and Finish

- 4.2.1 Contact: High performance copper alloy (Phosphor Bronze)
Finish: (a) Contact Area: Refer to the drawing.
(b) Under plate: Refer to the drawing.
(c) Solder area: Refer to the drawing.
- 4.2.2 Housing: Thermoplastic or Thermoplastic High Temp., UL94V-0
- 4.2.3 Actuator: Thermoplastic or Thermoplastic High Temp., UL94V-0
- 4.2.4 Fitting Nail: Copper Alloy, Finish: Refer to the drawing.

4.3 Ratings

- 4.3.1 Working voltage less than 36 volts AC (per pin)
- 4.3.2 Voltage: 50 Volts AC (per pin)
- 4.3.3 Current: 0.5 Amperes (per pin)
- 4.3.4 Operating Temperature : -40°C to +85°C

TITLE: **1.0 PITCH EASY ON FPC CONN SMT R/A B/C TYPE**

RELEASE DATE: 2018/12/26

REVISION: A

ECN No: ECN-1812458

PAGE: **5** OF **15**

5 Performance

5.1. Test Requirements and Procedures Summary

Item	Requirement	Standard
Examination of Product	Product shall meet requirements of applicable product drawing and specification.	Visual, dimensional and functional per applicable quality inspection plan.
ELECTRICAL		
Item	Requirement	Standard
Low Level Contact Resistance	55 m Ω Max.(intial) per contact 20 m Ω Max.Change allowed	Mate connectors, measure by dry circuit, 20mV Max., 100mA Max. (EIA-364-23)
Insulation Resistance	500 M Ω Min.	Unmated connectors, apply 500 V DC between adjacent terminals. (EIA-364-21)
Dielectric Withstanding Voltage	No discharge, flashover or breakdown. Current leakage: 1 mA max.	300 VAC Min. at sea level for 1 minute. Test between adjacent contacts of unmated connectors. (EIA-364-20)
Temperature rise	30°C Max. Change allowed	Mate connector: measure the temperature rise at rated current until temperature stable. The ambient condition is still air at 25°C (EIA-364-70, METHOD1,CONDITION1)

TITLE: 1.0 PITCH EASY ON FPC CONN SMT R/A B/C TYPE

RELEASE DATE: 2018/12/26

REVISION: A

ECN No: ECN-1812458

PAGE: **6** OF **15**

MECHANICAL

Item	Requirement	Standard
Durability	20 cycles.	The sample should be mounted in the tester and fully mated and unmated the number of cycles specified at the rate of 10± 3mm/min. (EIA-364-09)
FPC Retention Force	0.08Kgf/Pin MIN.	A connector shall be soldered on a board and insert the actuator, pull the FPC at the speed rate of 25.4 ± 3 mm/min.
Terminal /Housing Retention Force	0.08kgf MIN.	Operation Speed : 25.4 ± 3 mm/minute. Measure the contact retention force with Tensile strength tester.
Fitting Nail /Housing Retention Force	0.08kgf MIN.	Operation Speed : 25.4 ± 3 mm/minute. Measure the contact retention force with Tensile strength tester.
Vibration	1 μs Max.	The electrical load condition shall be 100 mA maximum for all contacts. Subject to a simple harmonic motion having amplitude of 0.76mm (1.52mm maximum total excursion) in frequency between the limits of 10 and 55 Hz. The entire frequency range, from 10 to 55 Hz and return to 10 Hz, shall be traversed in approximately 1 minute. This motion shall be applied for 2 hours in each of three mutually perpendicular directions. (EIA-364-28 Condition I)
Shock (Mechanical)	1 μs Max.	Subject mated connectors to 50 G's (peak value) half-sine shock pulses of 11 milliseconds duration. Three shocks in each direction shall be applied along the three mutually perpendicular axes of the test specimen (18 shocks). The electrical load condition shall be 100mA maximum for all contacts. (EIA-364-27, test condition A)

TITLE: 1.0 PITCH EASY ON FPC CONN SMT R/A B/C TYPE

RELEASE DATE: 2018/12/26

REVISION: A

ECN No: ECN-1812458

PAGE: **7** OF **15**

ENVIRONMENTAL

Item	Requirement	Standard
Resistance to Reflow Soldering Heat	See Product Qualification and Test Sequence Group 10 (Lead Free) Appearance: No damage	Pre Heat : 150°C~180°C, 60~120sec. Heat : 230°C Min., 40sec Min. Peak Temp. : 260°C Max, 10sec Max. Reflow unumber cycle:2 times (EIA-364-56)
Thermal Shock	Appearance :No damage Contact Resistance:75mΩ Max. Insulation Resistance:500MΩ Min. Dielectric Withstanding Voltage: No breakdown	Mate module and subject to follow condition for 5 cycles. 1 cycles: -55 +0/-3 °C , 30 minutes +85 +3/-0 °C , 30 minutes (EIA-364-32, test condition I)
Humidity	Appearance :No damage Contact Resistance:75mΩ Max. Insulation Resistance:500MΩ Min. Dielectric Withstanding Voltage: No breakdown	Mated Connector 40°C , 90~95% RH, 96 hours. (EIA-364-31,Condition A, Method II)
Temperature life	Appearance :No damage Contact Resistance:75mΩ Max. Insulation Resistance:500MΩ Min. Dielectric Withstanding Voltage: No breakdown	Subject mated connectors to temperature life at 85°C for 96 hours. (EIA-364-17, Test condition A)
Salt Spray (Only For Gold Plating)	Appearance :No damage	Subject mated/unmated connectors to 5% salt-solution concentration, 35°C (I) Gold flash for 8 hours (II) Gold plating 3 u" for 48 hours (III) Gold plating ≥ 5 u" for 96 hours (EIA-364-26)
Solder ability	Tin plating: Solder able area shall have minimum of 95% solder coverage. Gold plating: Solder able area shall have minimum of 75% solder coverage	And then into solder bath, Temperature at 245 ±5°C, for 4-5 sec. (EIA-364-52)
Hand Soldering Temperature Resistance	Appearance: No damage	T ≥ 350°C , 3sec at least.

Note. Flowing Mixed Gas shell be conduct by customer request.

TITLE: **1.0 PITCH EASY ON FPC CONN SMT R/A B/C TYPE**

RELEASE DATE: 2018/12/26

REVISION: A

ECN No: ECN-1812458

PAGE: **8** OF **15**

6 INFRARED REFLOW CONDITION

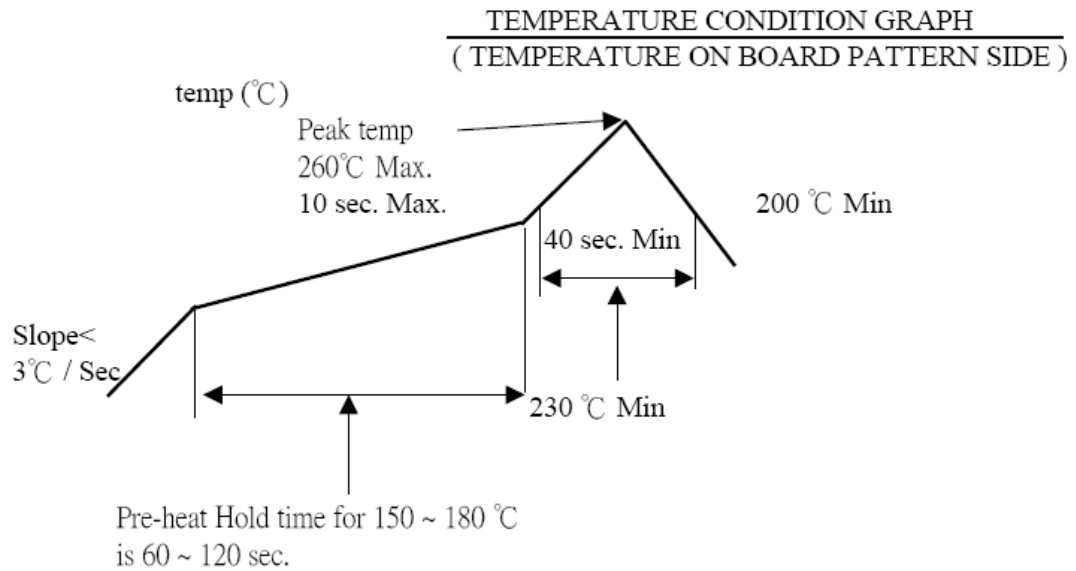

TITLE: **1.0 PITCH EASY ON FPC CONN SMT R/A B/C TYPE**

RELEASE DATE: 2018/12/26

REVISION: A

ECN No: ECN-1812458

PAGE: **9** OF **15**

7 PRODUCT QUALIFICATION AND TEST SEQUENCE

Test or Examination	Test Group										
	1	2	3	4	5	6	7	8	9	10	11
	Test Sequence										
Examination of Product				1、7	1、6	1、4		1、3		1、3	
Low Level Contact Resistance		1、5	1、4	2、10	2、9	2、5					
Insulation Resistance				3、9	3、8						
Dielectric Withstanding Voltage				4、8	4、7						
Temperature rise	1										
Durability		3									
Vibration			2								
Shock (Mechanical)			3								
Thermal Shock				5							
Humidity				6							
Temperature life					5						
Salt Spray(Only For Gold Plating)						3					
Solder ability							1				
FPC Retention Force		2、4									
Terminal / Housing Retention Force									1		
Fitting Nail /Housing Retention Force											1
Resistance to Soldering Heat										2	
Hand Soldering Temperature Resistance								2			
Sample Size	2	4	4	4	4	4	2	4	4	4	4

TITLE: **1.0 PITCH EASY ON FPC CONN SMT R/A B/C TYPE**

RELEASE DATE: 2018/12/26

REVISION: A

ECN No: ECN-1812458

PAGE: **10** OF **15**

8 CONNECTOR OPERATION

OPERATION

FPC insertion procedure. Connector installed on the board.

1) Lift up the actuator. Use thumb or index finger.

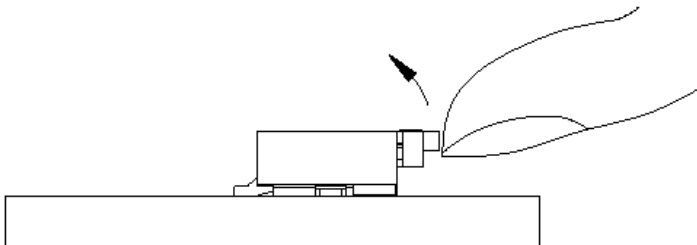

2) Fully insert the FPC in the connector parallel to mounting surface, with the exposed conductive traces facing down.

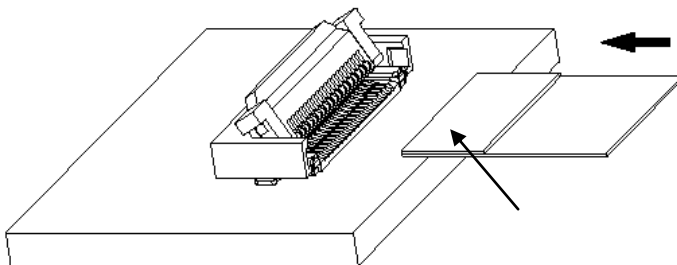

3) Rotate down the actuator until firmly closed. It is critical that the inserted FPC is not moved and remains fully inserted.

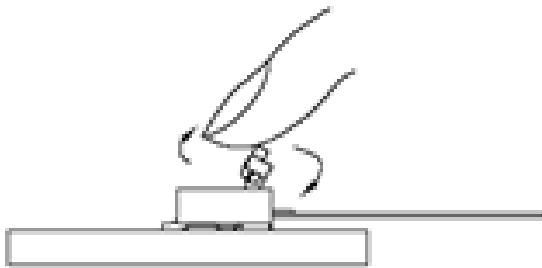

TITLE: 1.0 PITCH EASY ON FPC CONN SMT R/A B/C TYPE

RELEASE DATE: 2018/12/26

REVISION: A

ECN No: ECN-1812458

PAGE: **11** OF **15**

FPC/FFC Removal

- 1) Lift up the actuator.
- 2) Carefully remove the FPC/FFC.

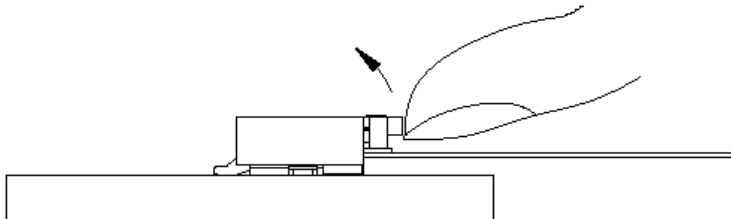

PRECAUTIONS

PC board flexing

- 1) SPC board connector mounting area

The connectors are straight within 0.1 mm max.

Make sure that the PC board connector mounting area flatness can accept the connector terminals without causing any failure of the solder joints.

- 2) SHandling before mounting on PCB

Insertion of the FPC or operation of the actuator prior to mounting on the PCB is **NOT RECOMMENDED**.

- 3) SPC Board handling

Exercise caution when handling boards with the connectors installed. Do not apply any forces affecting soldered joints.

A. Lock release

Carefully rotate the actuator up to 90°, lifting it at the center.

- The actuator opens by rotating it in the direction **OPPOSITE** to the direction of the insertion of the FPC. **DO NOT** attempt to open it from the same side as the insertion of the FPC.

TITLE: 1.0 PITCH EASY ON FPC CONN SMT R/A B/C TYPE

RELEASE DATE: 2018/12/26

REVISION: A

ECN No: ECN-1812458

PAGE: **12** OF **15**

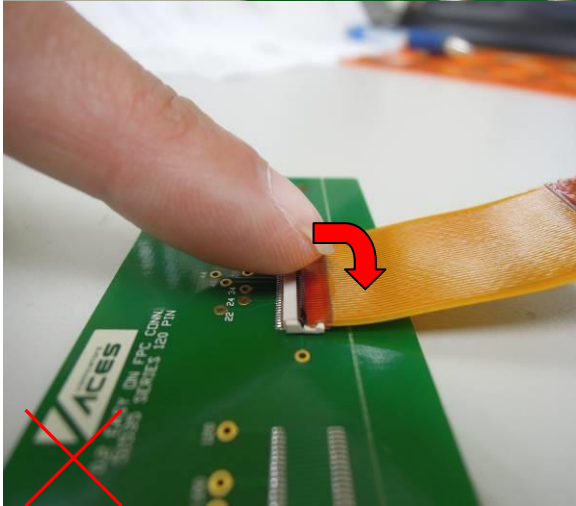
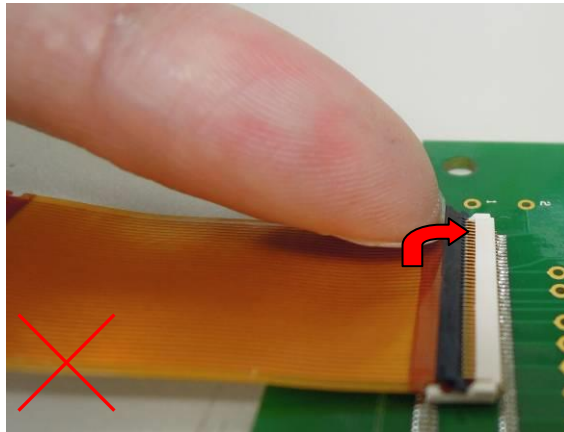
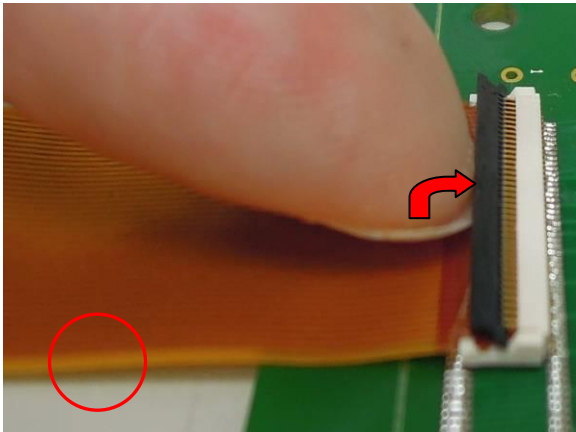

TITLE: 1.0 PITCH EASY ON FPC CONN SMT R/A B/C TYPE

RELEASE DATE: 2018/12/26

REVISION: A

ECN No: ECN-1812458

PAGE: **13** OF **15**

- 1) Do when you pull out mating FPC/FFC with the Actuator opened completely. Confirm whether to Have adhered to the terminal contact part before FPC/FFC is mated with the connector housing when the opening of the actuator is the un-complete and FPC/FFC is pulled out.

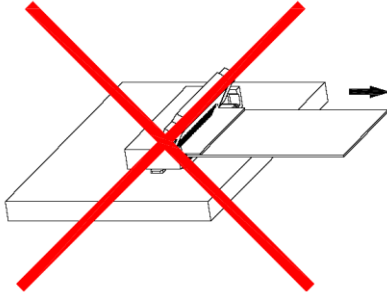

- 2) Do not add the load mating FPC/FFC with connector housing.

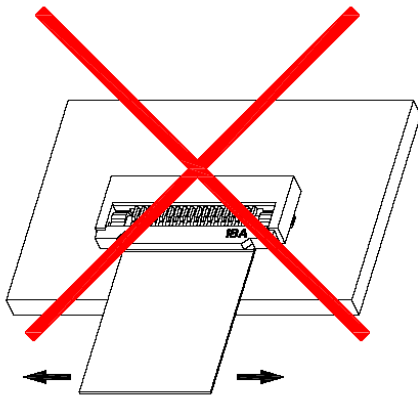

- 3) Due to the structure of the connectors, they do not have string resistance to upward pulling; therefore, support the FPC/FFC when a pulling force is applied to it.

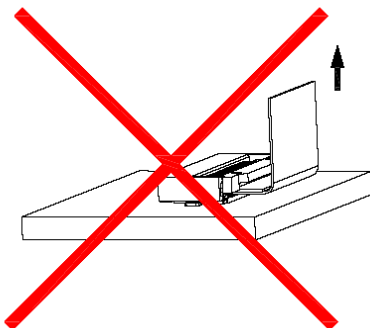

TITLE: 1.0 PITCH EASY ON FPC CONN SMT R/A B/C TYPE

RELEASE DATE: 2018/12/26

REVISION: A

ECN No: ECN-1812458

PAGE: **14** OF **15**

4) This connector is small and thin and requires delicate and careful handling.

Be very careful not to apply any force to the FPC after inserting it.
Otherwise, the connector may become unlocked or the FPC may break.
Fix the FPC, in particular, when loads are applied to it continuously.
Design the FPC layout with care not to bend it sharply near the insertion opening.

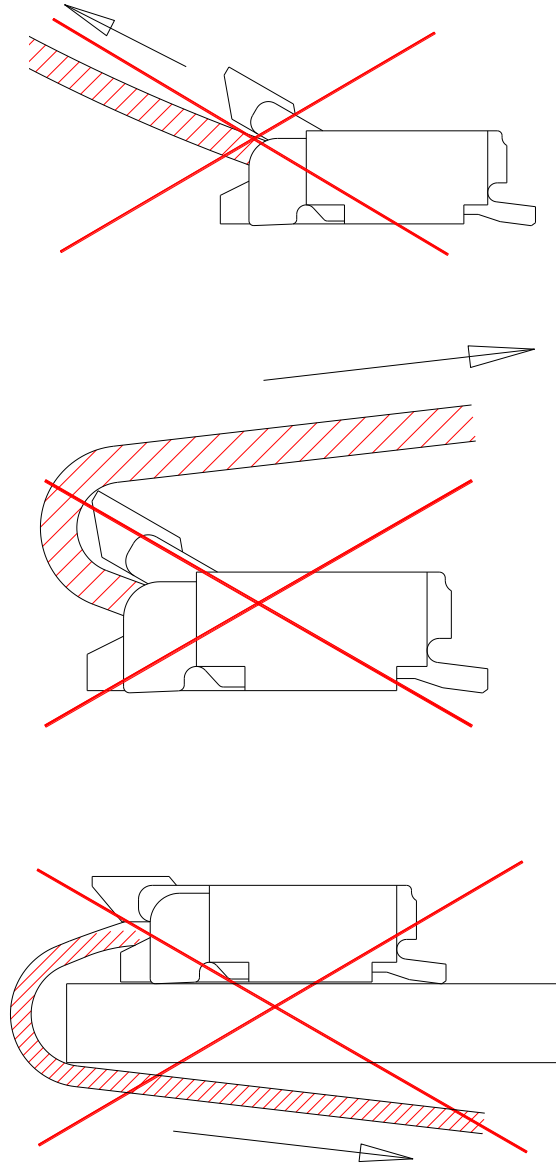

TITLE: 1.0 PITCH EASY ON FPC CONN SMT R/A B/C TYPE

RELEASE DATE: 2018/12/26

REVISION: A

ECN No: ECN-1812458

PAGE: **15** OF **15**

FPC Bending Direction: UP

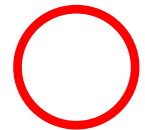
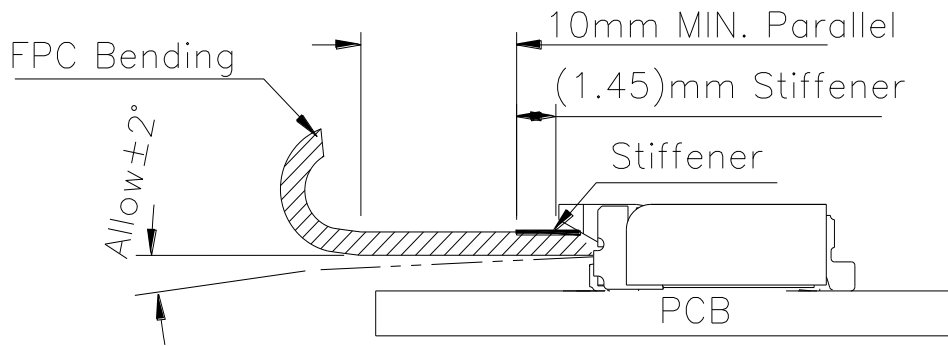

FPC Bending Direction: DOWN

